

Manual

OVERVIEW >>>

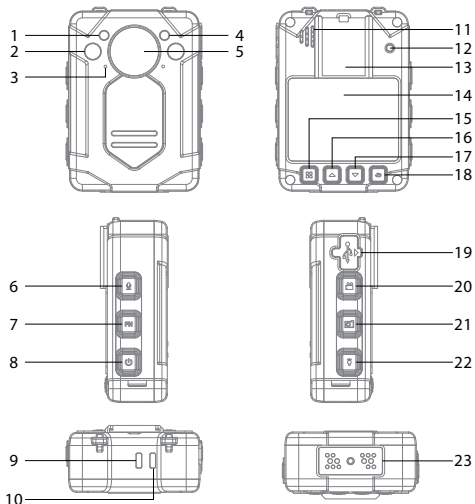

- | | |
|----------------------------|--------------------------------|
| 1. Photoresistor | 13. Clip Slot |
| 2. IR LED Light | 14. Display Screen |
| 3. Microphone | 15. Menu/Confirm Button |
| 4. LED Fill Light | 16. Up/Left Button |
| 5. Lens | 17. Down/Right Button |
| 6. Audio Recording Button | 18. Back Button |
| 7. Video Resolution Switch | 19. USB port |
| 8. Power ON/OFF | 20. Video Recording Button |
| 9. Charging/WIFI Indicator | 21. Photo Button |
| 10. Working Indicator | 22. Fill Light/ Tagging Button |
| 11. Loudspeaker | 23. Dock Interface |
| 12. Reset Button | |

FUNCTIONALITIES >>>

No.	Description	Functionality
2	IR LED Light	Infrared LED can record more details in low-light environment.
5	Lens	To record images
6	Audio Recording Button	Press this button to start/stop recording audio file.
8	Powe ON/OFF	Single-press this button to turn on camera. Press and hold this button to turn of camera, when camera is powered on, single-press this button to turn on/off screen LED.
9	Charging/WIFI Indicator	Charging indicator is blue, when battery is fully charged, this indicator will be off.
10	Working Indicator	In standby mode, this indicator will be green. When recording video, this indicator will be red and blinking. When recording a audio file, this indicator will be orange and blinking. When taking a picture, this indicator will be red and flash once.
12	Reset Button	Resetting camera will power off the camera forcibly, it helps when the camera is down.
13	Clip Slot	This camera can be assembled with a 360-degree rotatable clip.
14	TFT LCD display	2.0 inches display screen
15	Menu/Confirm Button	Press Menu button in Preview Mode(After camera powered on, the unit will enter into Preview Mode) to enter menus, and press this button to enter sub-menus.
16	Up/Left Button	Press this button move cursor Up/Left. In Preview Mode, press and hold this button Zoom out.
17	Down/Right Button	Press this button move cursor Down/Right. In Preview Mode, press and hold this button Zoom in.
18	Back Button	Press this button to return to previous menu.
19	USB port	Charging device via using USB cable to connect to PC or wall socket. Uploading data via using USB cable to connect to PC.
20	Video Recording Button	Press this button to start/stop recording in Preview Mode. Press and hold this for about 3 seconds to turn on camera and start recording immediately.
21	Photo Button	Press this button to take picture. Press and hold this button to turn on/off flashing fill light.
22	Fill Light	Press this button to turn on/off Infrared LED light. Press and hold this button to turn on/off fill light.

SPECIFICATIONS >>>

Specifications	
Image Sensor	CMOS
Video Resolution	2304x1296p(30 FPS) / 1920x1080P(30 FPS) 1280x720(60 FPS)/ 1280x720(30 FPS)
Video Format	H.264 .MOV
Watermark	User ID, Date&Time
Camera	32 Mega Pixels
Image Resolution	Up to 4608*3456 JPEG
Screenshot	Capture image while recording video
Recording Time	12 hours
Storage Space	32G/64G
Main Features	Video Recording, Audio Recording, Photographing, Auto IR
Infrared Light	2PCS
Camera	
FOV	140-degree
Night Vision	15 meters
Ingress Protection	Ip66
Clip	360-degree Rotatable
Battery	
Type	Built-in 3200mAh Li-ion Battery
Charging Time	3.5 hours
Others	
ID	8-character Device ID, 6-character User ID
Encryption	Password
Size	79 * 56.9 * 26.6mm
Weight	130g
Screen Size	2-inch
Standard Accessories	
USB cable, Charger, Clip, Manual	

1. Power ON/OFF

1) **Power ON** : Single-press  to turn on camera from OFF-mode, and enter into Preview Mode.

2) **Power OFF** : Press and hold  to turn off camera. Before shutting down, video being recorded will be saved.

2. Turn ON/OFF Screen Light

Single-press "Power Button"  to turn on/off screen light and save power.

3. Reset

Resetting camera will power off the camera forcibly, it helps when the camera is down.

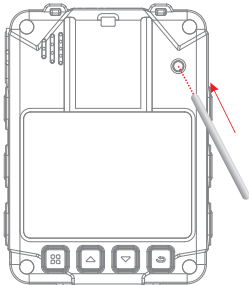

4. Infrared Light

In low-light environment (At night or in the dark), turning on IR can help user to record more details, and images recorded will be black and white.

In Preview Mode, press Menu button to enter Menus, and go to SETUP, find IR CUT in SETUP-Settings [SETUP-Video, SETUP-Photo, SETUP-Settings].

1) **Manual** : Single-press  to turn on/off Infrared Light.

2) **Auto** : At night or in the dark, when photoresistor senses the low-light environment, Infrared Light will be turned on/off automatically.

5. Photograph Feature

In Preview Mode, single-press , and the unit will start taking pictures similar to a digital camera. In SETUP menu, user can set image resolution, quality, burst capture and auto exposure.

6. Burst Mode



Burst Capture means to capture a continuous sequence of photos.

7. Screenshot

To capture picture while video is being recorded, just single-press .

8. Video Recording

In Preview Mode, single-press  to start recording video, press the button again to stop recording.

When using “Press and Hold”  to start recording, there will be a “” icon appeared, and the video will be saved in a special “Event” folder.



9. Video Splitter

To set “Video File Duration” in SETUP menu, videos recorded will split into clips in different length.

10. Pre-recording

In SETUP-Video menu, turn on Pre-record, the unit will pre-record 5-30 seconds prior to pressing “Video Recording” button.

11. Post-recording

In SETUP-Video menu, set Post-record with a specified length, the unit will automatically extend recording with the specified length.

12. Motion Detection

In SETUP-Video menu, turn on Motion Detect, single-press , the unit will start motion detecting, once the video scene moves or changes, camera will start recording. Then, if the video scene has not been moved or changed over 20 seconds, camera will stop recording.



13. Audio Recording

In Preview Mode, single-press  to record a audio file, press again to stop recording.

14. One Button Recording

Press and hold  in OFF-mode, camera will power on and start recording video immediately.

15. File Tagging

While video is being recorded, press and hold  for about 3 seconds, there will be a “” icon appeared, video recorded will be saved in “Event” folder. Single-press  again to cancel tagging.



16. Video resolution Switch

Single-press " **FN** " to change video resolution directly in Preview Mode.

17. Change User ID

Find "Change User ID" in SETUP-Settings, default password is 000000, use **FN** to confirm and press **▲** / **▼** to move the cursor.

18. Set Date&Time

Find "Date&Time" in SETUP-Settings, default password is 000000, use **FN** to confirm (or move to next) and press **▲** / **▼** to change the number.

19. Switch Between Video Recording and Audio Recording

1) When video is being recorded, press **🎤** to stop recording video and start audio recording, video will be saved.

19. Switch Between Video Recording and Audio Recording

- 1) When video is being recorded, press **🎤** to stop recording video and start audio recording, video will be saved.
- 2) When an audio file is being recorded, press **📹** to stop audio recording and start video recording, audio file will be saved.

20. Working as USB Flash Disk

Connect camera to PC via USB cable, enter correct password, and camera will be recognized like a USB flash disk on PC. Default password is **000000**.

21. Playback

- 1) Press **FN**, and find "Video, Photo, Audio", all files recorded can be browsed.
- 2) Press and Hold **FN** to check the last file recorded.

22. Charging

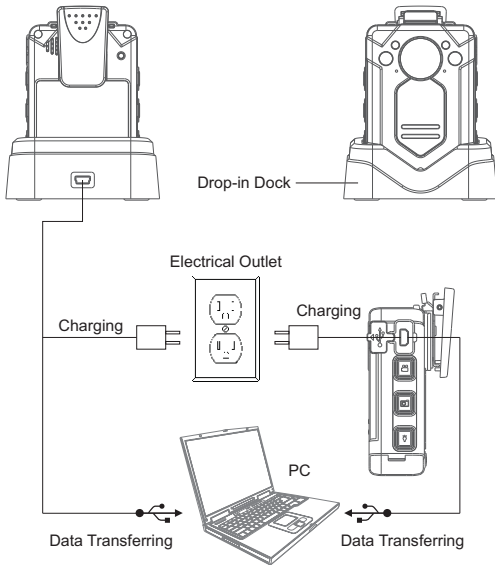

23. Connect with External Camera

Connect with external camera, the unit will record video via external camera, not the main camera.

Question	Analysis	Answer
Camera can't be powered on	Out of battery	Charge for 3.5 hours.
	Mainboard Protection	Use Reset button
Working time of camera is short	Camera was not fully charged	Charging time should not be less than 3.5 hours.
Data Uploading Interrupted frequently	Front panel of mainframe can't supply enough power	Use the USB port of back panel.
Camera can't be recognized by PC	USB cable issue	Change USB cable.
	Wrong driver	Reinstall driver.

NOTICE FOR USER >>>

Even if within the warranty period, if the following occurs, certain maintenance costs will be charged.

- 1) The malfunction and damaged caused by incorrect use, the unauthorized repairs and alteration.
- 2) The damage caused by fire, flood, abnormal voltage, other natural disasters and secondary product damage.

NOTICE FOR USER >>>

- 3) The product malfunction caused by the fall and transportation failures after purchase.
- 4) The product malfunction caused by Not in accordance with the user manual operation.
- 5) The malfunction and damaged caused by the other barriers (man-made factors or external device).